

SI-2322WR SI-2322WR-E Wet Sander

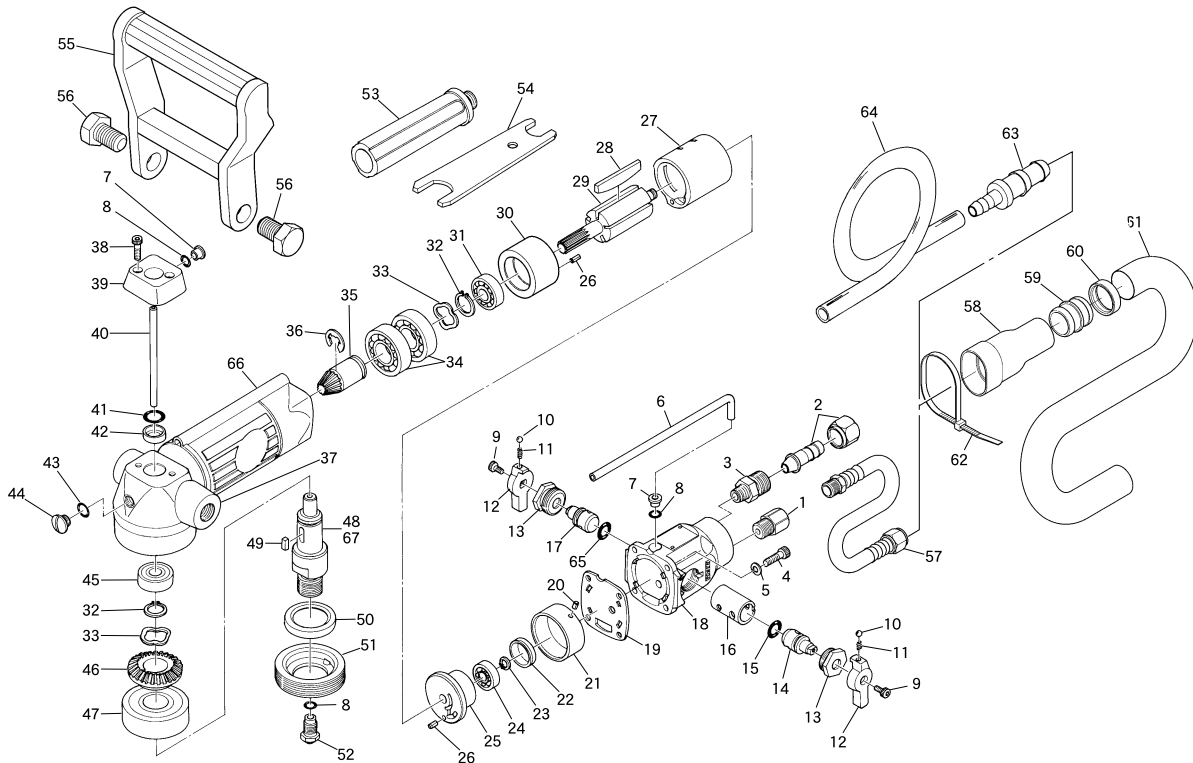

Ref. No.	Parts No.	Description	Q'ty	Ref. No.	Parts No.	Description	Q'ty
1	180-1	Inlet Bushing	1	36	1E-8	Retaining Ring	1
2	1110A-62	Hose Nipple	1	37	1110R-1A	Motor Housing	1
3	1110A-22	Hose Adaptor	1	38	Z-832--160	Cap Screw	2
4	Z-832-160	Cap Screw	4	39	1110-3A	Pipe Connector	1
5	HSW-40	Washer	4	40	1110-23	Inner Pipe	1
6	1110-9	Outer Pipe	1	41	S-12	O-Ring	1
7	1110-17	Pipe Bush	2	42	G8-14-4	Oil Seal	1
8	P-4	O-Ring	3	43	S-7	O-Ring	1
9	Z-M30-80	Cap Screw	2	44	1110A-6	Grease Plug	1
10	SB-1/8	Steel Ball	2	45	608-LLU	Ball Bearing	1
11	450-45	Regulator Spring	2	46	1110A-13	Bevel Gear	1
12	1110-4	Lever	2	47	6302-LLU	Ball Bearing	1
13	1110-21	Valve Nut	2	48	1110-11	Spindle (M16 P=2)	1
14	1110A-18	Air Valve	1	49	940-46	Key	1
15	P-7	O-Ring	1	50	G23-32-7	Oil Seal	1
16	1110A-20	Valve Bush	1	51	1110-15	Spindle Cap	1
17	1110A-19	Water Valve	1	52	1110A-16	Nozzle	1
18	1110R-2	Valve Housing	1	53	240-50	Dead Handle	1
19	1110R-3	Gasket	1	54	350-28	Spanner Wrench (14x19mm)	1
20	25-4	Roll Pin (2.5φ-4mm)	1	55	1110R-4	Handle	1
21	1110A-5	Rear Case	1	56	1110R-5	Bolt	2
22	680-34	Bearing Cap	1	57	106-3	Wipe Hose	1
23	JS-6	Retaining Ring	1	58	106-5	Exhaust Cover	1
24	626	Ball Bearing	1	59	106-6	Connector	1
25	1110-26A	Rear Plate	1	60	106-1	Urethane Band	1
26	25-5	Roll Pin (2.5φ-4mm)	2	61	106-2	Exhaust Hose	1
27	1110-24A	Cylinder	1	62	106-10	Harness Band	1
28	1110R-8	Rotor Blade	5	63	1110A-61	Water Hose Joint	1
29	1110R-7	Rotor	1	64	1110A-64	Water Hose	1
30	1110R-6	Front Plate	1	65	S-8	O-Ring	1
31	608-ZZ	Ball Bearing	1	66	1110A-8	Housing Cover	1
32	JS-15	Retaining Ring	2	★67	1110A-11E	Spindle (M14 P=2)	1
33	WW-150	Wave Washer	2	◆68	1110A-80	80mm Velcro Pad (M16 P=2)	
34	6002	Ball Bearing	2	◆69	1110A-80E	80mm Velcro Pad (M14 P=2)	
35	1110A-12	Pinion Gear	1				