

SI-3111(M) 5" Dual Action Sander (Dust Free)

SI-3111-6(M) 6" Dual Action Sander (Dust Free)

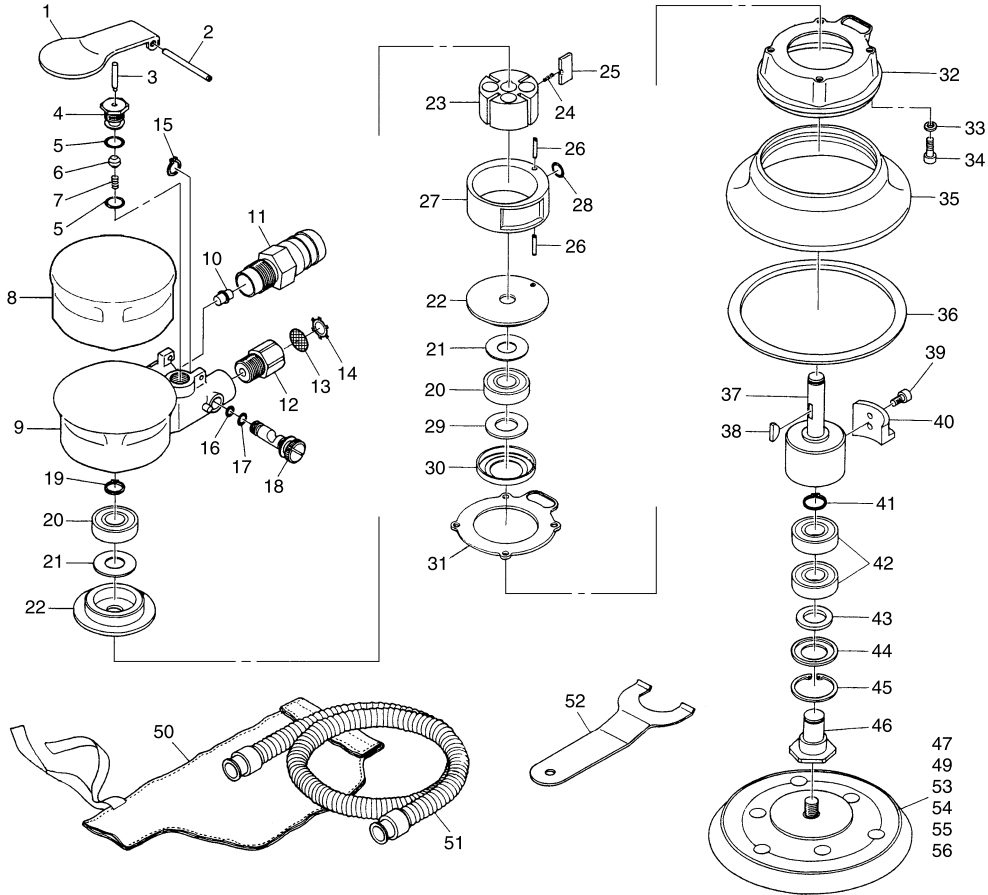

Ref. No.	Parts No.	Description	Q'ty	Ref. No.	Parts No.	Description	Q'ty
1	1040-11	Throttle Lever	1	29	570-1	Felt Ring	1
2	30-40	Roll Pin (3-40mm)	1	30	481-9	Seal Cover	1
3	455-11	Valve Pin	1	31	1040-9	Motor Gasket	1
4	490-4	Valve Body	1	32	1041-10	Balancer Cover	1
5	S-10	O-Ring	2	33	1040-19	Washer	4
6	455-21	Valve	1	34	Z-632-127	Cap Screw	4
7	490-20	Valve Spring	1	35	1041-14U5	Pad Cover	1
8	1040-10A	Housing Cover	1	36	1041-18U5	Felt Ring	1
9	1040-1	Motor Housing	1	37	1041-11	Balancer Shaft	1
10	1040-12	Nozzle	1	38	480-23	Key	1
11	1040-45D	Defuser	1	39	Z-M40-80	Cap Screw	2
12	180-1	Inlet Bushing	1	40	1041-13	Adjust Weight	1
13	680-28A	Screen	1	41	JS-12	Retaining Ring	1
14	CRTW-12	Retainer	1	42	6001-LLB	Ball Bearing	2
15	JS-8	Retaining Ring	1	43	1041-50	Felt	1
16	P-4	O-Ring	1	44	1041-51	Seal Plate	1
17	P-5	O-Ring	1	45	BO-28	Retaining Ring	1
18	485-4	Air Regulator	1	46	1041-12	Random Shaft	1
19	JS-10	Retaining Ring	1	47	M-125HD	5" Velcro Pad	1
20	6000-ZZ	Ball Bearing	2	49	M-150HD6	6" Velcro Pad 3M Type	1
21	890-1PB	Seal Plate	2	50	485-42	Dust Pack	1
22	1040-5A	End Plate	2	51	1040-54	Dust Hose	1
23	1040-4	Rotor	1	52	1041-56	Spanner Wrench	1
24	490-1	Blade Spring	2	53	P-125HD	5" Leather Pad	1
25	1040-17	Rotor Blade	4	54	P-150HD6	6" Leather Pad 3M Type	1
26	25-14	Roll Pin (2.5-14mm)	2	55	M-150HD3-9	6" Velcro Pad	1
27	1040-2	Cylinder	1	56	P-150HD3-9	6" Leather Pad	1
28	P-7	O-Ring	1				